

ADSURE PACKAGING LIMITED

Auto Pre-open Bag

Over
36 years'
experiences

Automatic Pre-Opened Perforated
APOP®



Custom Design and Print Service

From conceptual design to prototype samples, we provide artworks and custom print services.

Quality Assurance

We have advanced quality control system for tracking and tracing the product quality before, during and after the production processes.



www.AdsurePackaging.com



Team

Adsurre® Packaging Limited

Adsurre® Packaging is a leader in designing and manufacturing functional flexible bags in China.

And we provide a series of Auto Packaging solutions for multiple applications, which helps customers with high efficiency operation & saving cost.

We have continued to innovate and grow on our production capacity. Different country, different application packaging requirement have been got together in Adsurre®.

Professional packaging experiences are not only belongs to us, but also share with to our customers.

Today, we have been the manufacturer of APOP® Bags (auto pre-opened packaging bags) on a roll or fan-folded in a box, and a full line of baggers, and bag packaging equipment.

ADSURE® = **AD**vanced Technology to en**SURE** security packaging

= The Quality and Trusted partner for Security Packaging

Contents

Introduction	2-3
Aptitude honor	4
Application Fields	5
APOP® Auto Pre-opened Bags	6
Standard APOPTM Bags	7
Auto Bag with Handle	8
SidePouch Pre-Opened Bag	9
Custom Bag Styles	10
Custom Printing	11
Custom Features	12
Custom Materials	13
Quality System	14
Testing method	15

Our Goal:

100% Customer Satisfaction



Why Choose Us?

● Professional Packaging Solutions

Over 36 years' plastic packaging experience; continuous improvement and innovation technology, Adsure® keep offering better packaging solutions.

● Quality Assurance

Adsure factory complies with ISO 9001:2015, SGS, Adsure own laboratory to make related testing timely.

Our testing equipments includes:

- OCR System
- Microscope
- Optical Density Meter
- Color Assessment Cabinets
- Missing No. Report System
- Film Falling Dart Impact Tester
- Tensile Strength Testing Machine
- Friction Coefficient Testing Machine
- Temperature Humidity Programmable Chamber
- Colorimeter

● Customization

Range: Material; Size; Printing.

Add value: Free of artwork; Free of design; Free of different packaging solution before order.

Product Tolerances

Quantity: $\pm 10\%$ of order QTY

Size: $\pm 5\text{mm}$ Width & Length
 $\pm 0.002\text{mm}$ Thickness

Lead Time

Stock products: 1-7days

MOQ: 3-4 weeks working days

Flexible production time for special urgent order.

Price Term: EXW, FOB, CNF, CIF, LDP, DDU.

Payment Methods

Deposit before mass production; balance before shipment.

Flexible payment terms for VIP customers.

T/T

PayPal

WESTERN UNION WU

CONTACT US

Phone: + (86) 18018772752

Wechat: + (86) 18018772752

Skype: GZBQ11

Web: www.AdsurePackaging.com

Email: sales01@adsurepackaging.com





Aptitude honor





Hardware & Fasteners



Electronics



Application Fields



Coins & Financial Products



Personal Product and Cosmetic



Pharmaceutical Fulfillment



Apparel & Accessory Packaging



Food



Healthcare



Crafts



Household products



Toys



Mail Order Fulfillment



Pet Products



Agriculture & Testing

APOP® Markets Served

Adsure provides innovative bagging machinery, Pre-opened bag on Roll / Pre-opened bag in a box, professional service and packaging solution.

It helps customers streamline packaging operations: improving operation efficiency, saving labor and time; maximizing the rate of output.



APOP® Auto Pre-opened Bags

APOP® bags are used for automated packaging machines.

Accepting customized order and prepared some standard stock.

APOP® Bags Solutions help client reducing labor & packaging cost; improving working efficiency.

Standard Features

1. Pre-Opened for feeding
2. Connect by Perforation line on Roll
3. Air hole: Flutter vent / Vent hole
4. Apply for thermal printing directly
5. On-roll / Fan-folded
6. Easy to open by horizontal / vertical perforation line

Custom Options

- Material: PE / Biodegradable / Compostable / Green PE / VCI / Anti-static / UV
- Bag Styles: Handle / Vent Hole / Euroloop / Wicket / Ziplock
- Packaging: On-roll / Fan-folded

Application

- Coins & Financial Products
- Healthcare
- Pharmaceutical Fulfillment
- Hardware & Fasteners
- Apparel & Accessory Packaging
- Food
- Crafts
- Electronics
- Personal Product and Cosmetic
- Mail Order Fulfillment

Standard APOP® Bags



Clear



Clear & White



White

W" x L"	Thickness	Bags/Roll	Roll/Case
3" x 5"	2 mil	3000	12
4" x 6"	2 mil	2500	8
5" x 7"	2 mil	2000	8
6" x 8"	2 mil	1750	8
8" x 10"	2 mil	1500	4
9" x 12.5"	2 mil	1250	4

Technical Information

Performance Data:	U/M	1.54/SD	2.0/ET	2.8/ST	ASTM
Puncture Resistance (Dart)	grams	220	315	380	D-1709
Tensile Strength MD	psi	4600	4335	4290	D-882A
Tensile Strength TD	psi	3695	3660	3530	D-882A
Elongation MD	%	530	540	618	D-882A
Elongation TD	%	640	650	670	D-882A
Elmendorf Tear MD	grams	378	575	980	D-1922
Elmendorf Tear TD	grams	940	1158	1400	D-1922

* SD=Standard Duty ST=Super Tuff ET=Extra Tuff

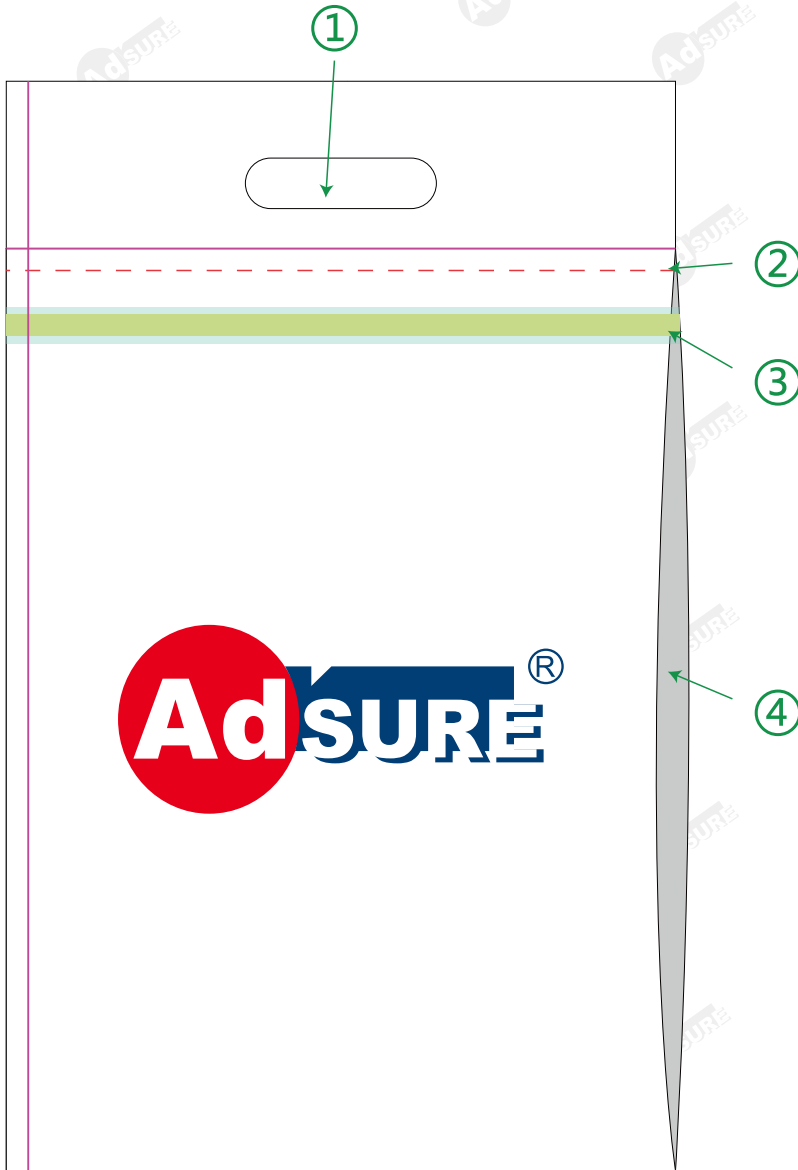

Auto Bag with Handle

Application

- E-commerce & Online Store
- Apparel & Accessory Packaging

Custom Options

- Size
- Material
- Print
- Handle
- Vent Hole
- Perforations

Features:

1. Handle



Convenient for carrying and transportation.

2. Perforation line

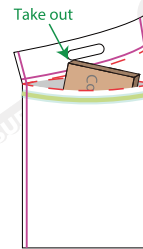

Easy open without scissors for ender user.

3. Glue

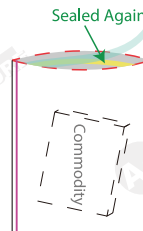

Additional glue reuse the bag by eco-friendly design.

4. Packaging

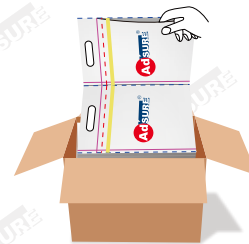

Fan-folded

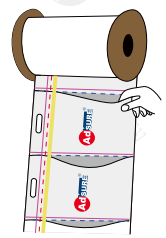

On Rolls

SidePouch Pre-Opened Bag

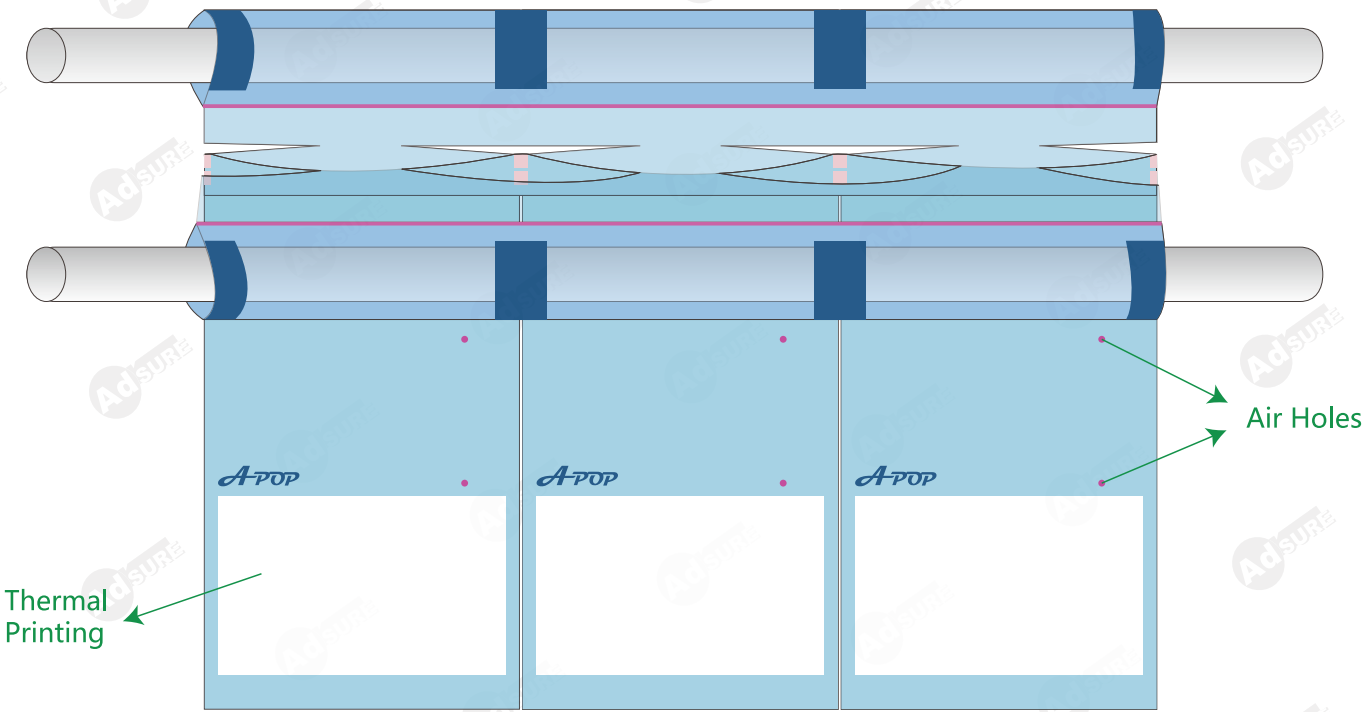

Application

- Ziplock / Resealable Bags / Reinforced Headers / Easy-open Perforations
- Fan-folded in a box
- Used for variety applications from food to e-commerce high-productivity solutions
- Pre opened design to help client feed the content easily and efficiency.
- Super customized capability meet different design for special auto machine.

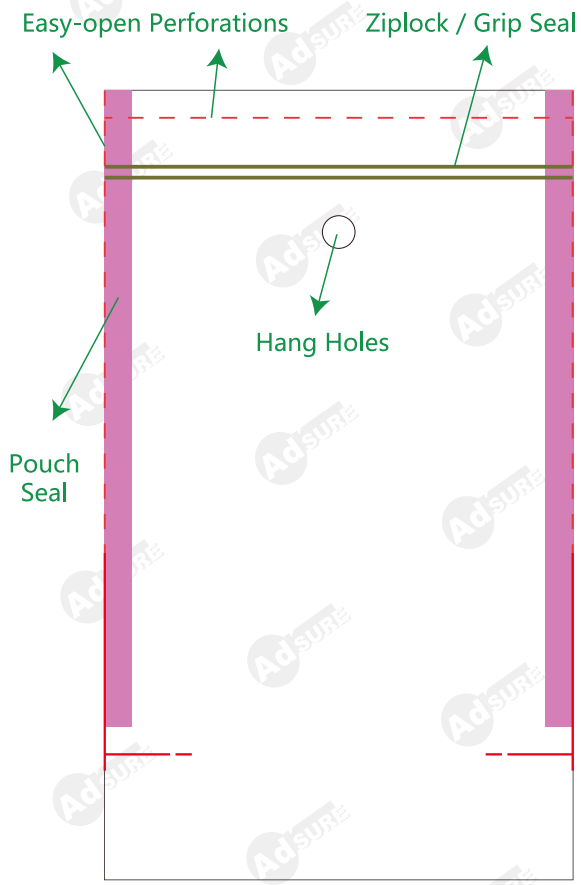

Custom Bag Styles

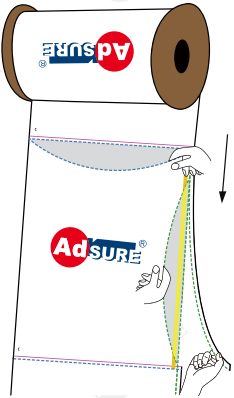

Returnable

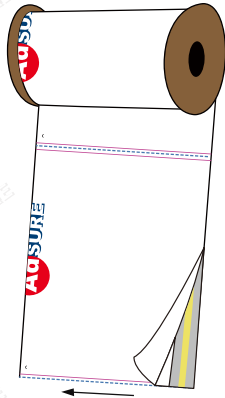

Poly Mailer on Rolls

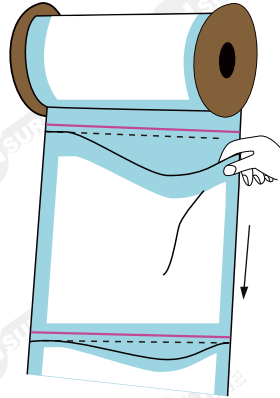

Thermal Printing



Fanfolded

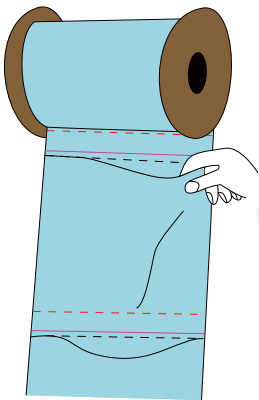

Bottom easy to pull dotted line

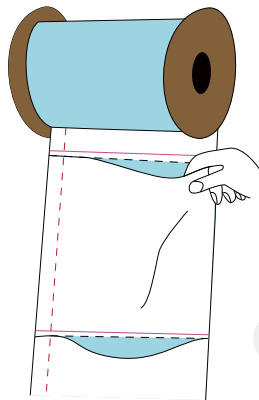

Clear + White Side

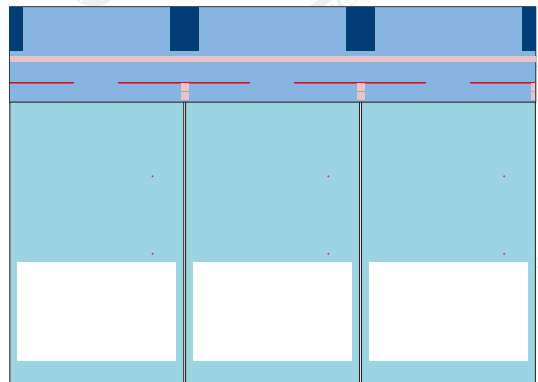

Side Loading Bag

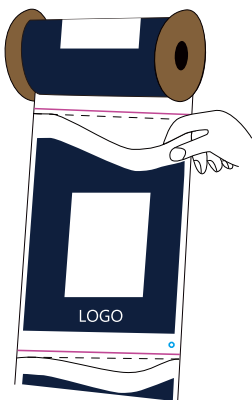

Full Print

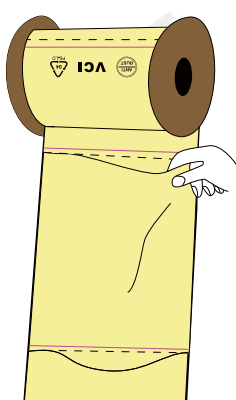

Anti Rust (VCI)



Anti Static (ESD)

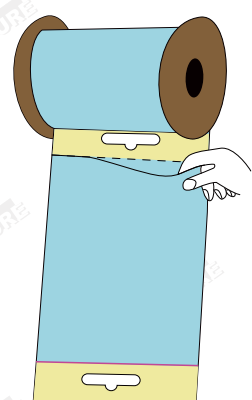

Euro Slot

Custom printing

- Flexo / Gravure printer up to 10 colors.
- Custom printing solution.
- Own designer/advance device/excellent technology.
- Ability to match pantone matching system color or sample from customer.



Gravure & Flexo Plate Difference



Gravure Printing

VS

Flexo Printing

- Line size: 0.12 mm / 0.25 point.
- CMYK/Picture/Complex Printing.
- Full floods up to 100%.
- Delicacy / Solid / Rich texture.
- Grave the images and words on metal rolls.
- Rather costly.
- Speed: 100-120m / minutes

- Line size: 0.2mm / 1.5 point.
- Rougher and simple content.
- 5mm blank on each edge; Max 95% coverage.
- Roughness / simply words / unsolid.
- Emboss Contents on resin plates.
- Economy.
- Speed: 30-40m / minutes.

Hot Stamping Process



Tyvek Material
Gold Foil Hot Stamping

Tyvek Material
Black Hot Stamping

Pink PE Material
Silver Foil Hot Stamping

Bright Black PE Material
Gold Foil Hot Stamping

Custom Features

Custom Size

Bag Thick	10-250 Mil
Bag Width	2" - 36"
Bag Length	2" - 72"

Perforations & Notches

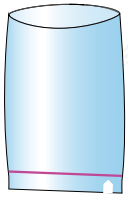

Tear Notch

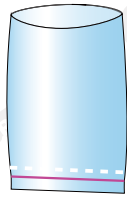

Horizontal Perforation

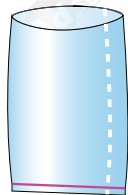

Vertical Perforation

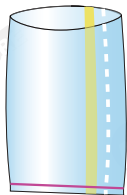

Self-Adhesive tape with perforation line

Vent Hole



Round Vent



No Through-holes



Flutter Vent



Crescent-shaped

Handle & Hang Holes



Handle



half-moon



Arched



Perforated Handle Line



Euro slot (Butterfly Hanger)



Allotype

The Plug

Metal & Plastic.



Paper Plate

Customize Printing / Thickness / Material



Core

Plain / Printed logo; Paper / Plastic material



Pre-open Perforation Line

Adapt different pre-open perforation line to meet with machine's tearing tension

Ziplock Closure

Reusable for Ender User

Self-Adhesive tape with perforation line

Open the package easily by the perforation line. Can reuse and Eco-Friendly

Tear Notch

Easy to tear notch on anywhere

Vent Hole

Trapped air / Reduce Size

Hang Holes

Easy to hang on Perfectly show the product on display hook

Bi-ex Bags (Duplex Bag)

Front Clear Back White film / better for Printing with visible view

High-Integrity Seals

5mm / 10mm pouch welding; leak proof; Withstand heavy content.

Material	Features	Application
Clear Polypropylene	<ol style="list-style-type: none"> 1. Super transparency 2. Recyclable 	<ul style="list-style-type: none"> ● Automotive Parts ● Small household appliances ● Other Retail Applications ● Toys
Clear Polyethylene	<ol style="list-style-type: none"> 1. High transparency 2. Used in general purpose / Recyclable 	<ul style="list-style-type: none"> ● Automotive Parts ● Food Craft Items ● Electronic Components ● Other Retail Applications ● Hardware ● Medical Devices
Front Clear Back Colored PE	<ol style="list-style-type: none"> 1. Easy to see content. 2. Easy to print and read information 3. Recyclable 	<ul style="list-style-type: none"> ● Automotive Parts ● Mail Order Fulfillment ● Retail Packaging ● Frozen Foods ● Hardware ● Crafts ● Medical ● Fasteners
Coextruded (Coex) Polyethylene	<ol style="list-style-type: none"> 1. 100% opaque, 100% privacy 2. Printed on bag directly 3. Recyclable 	<ul style="list-style-type: none"> ● Bulk Parcels ● Photographic Film ● Pharmacy Fulfillment ● Mail Order ● Medical
Nylon	<ol style="list-style-type: none"> 1. High prevention 2. Extra extension 3. Excellent oxygen barrier / CO2 performance 	<ul style="list-style-type: none"> ● Food ● Automotive Products ● Electronics
Biodegradable	EPI material: Accelerate decomposition speed, complies with environmental protection policy.	Eco-friendly Solution
Compostable	PBAT + PLA +Cornstarch / Green PE / 100% Biodegradable.	
Recycled	Eco-Friendly.	
Anti-static	Anti-static, prevent quality problems caused by short circuit of electronic products.	<ul style="list-style-type: none"> ● Electrical ● Components ● Electronic ● Kits
VCI	Anti-rust	<p>Ideal for Bag Packaging of Ferrous Metals:</p> <ul style="list-style-type: none"> ● Automotive ● Medical Devices ● Aerospace ● Jewelry
UV	Prevent the products form the influences of UV.	<ul style="list-style-type: none"> ● Pharmacy Fulfillment ● Unit Dose Packaging ● Security ● Mail Order ● Medical

How to control the APOP® bag quality

Only the best quality bags leads to your satisfaction. To ensure this, we keep improving our equipments during the mass production process, strive for the best quality until our customers satisfied with the product.

Keep innovation is the best way to exceed customers' expectation. Our professional R&D team focus on developing the new production process and products. So far, we have already obtained over 12 patents, and will keep the hard work.

Opening Rate	Fixed frequency change Blade / Online checking device / On time date track & trace each machine / Order
Production Track & Trace	Record each roll Connectors(≤ 2pcs/roll) / Self checking & QC Checking 2pcs production sample from each Roll
Easy to open	Adjusting film coefficient of friction, material composition to suit for different application.
Connectors	Invented own repairing tape, perfectly reconnect the bags, keep the baggers nonstop working.
Perforation Line Grade	Customize the perforated mould as our customers requires, according to tearing off strength choose suitable perforation line.
Bag Tolerance	With ISO 9001:2015 standard & MIL STD-105E sample checking.



On rolls



Fan-folded in a box



Automatic Packaging Machine

Test methods for plastic bags

- Using a rule, mark out the outline of the test sample as depicted below by the dotted green line [Figure 1];
 - P1 = 20mm x 33mm
 - P2 = 100mm x 33mm
- Using a scalpel or scissors, cut the sample from bag marked out in Step 1.
- Cut between the side seal so that both sides of the bag [front; clear, back; white] are separated. Keep both pieces as the test is to be completed on both sides.
- Take the white film layer of the bag and secure the full length of P1 with tape.
- Secure P2 onto the force gauge with tape. Ensure that force gauge is within the center [Figure 2].
- Ensure that the test strip and force gauge line up horizontally [Figure 4].
- Check that the force gauge is set to zero [Figure 4].
- Pull test P2 away from P1 until both parts are separated [Figure 5].
- Check the force gauge reading.
- Repeat the test on the clear film, so that both sides of the bag with the perforation have been tested.

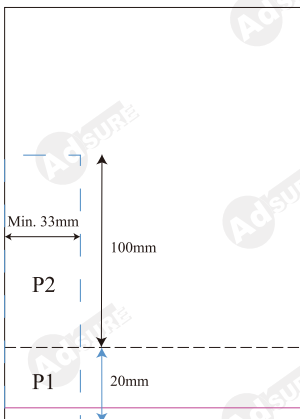

Figure 1. Cutting a sample for testing



Figure 2. Top View of Setup



Figure 3. If required, Provide gentle support at the top



Figure 4 Ensure that the test strip and force gauge line up horizontally



Figure 5. Ensure Complete Separation of P1 and P2



Security Packaging Manufacturer

Security Packaging Solution for Multiple Applications

Our Team



Our Laboratory



Our Meeting Rooms



Our Workshop



Our Warehouse



www.AdsurePackaging.com

Sales01@AdsurePackaging.com